

2 EPzB 150

Additional information

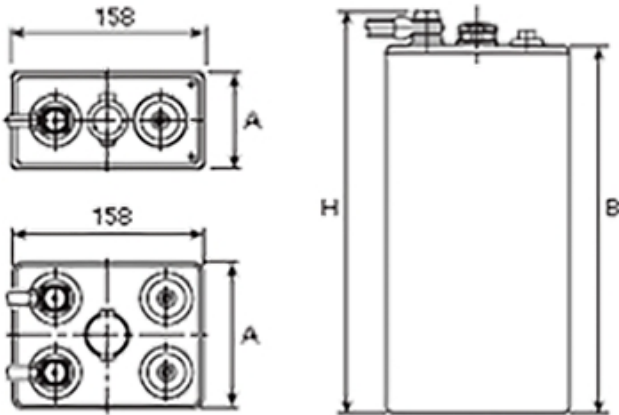

Brand	<i>Pegasus</i>
Range	<i>British Standard – Wet Vented 2 Volt Cell</i>
Volts	2
Number of plates	2
Cap [C5 Ah]	150
Weight	10.3 kg
Length	45 mm
Width	158 mm
Height	515 mm
Terminal Type	FM10
Technology	<i>WET – tubular plate</i>
Guarantee/Warranty	<i>BSH Vented British Standard (BS) and DIN Batteries (1500 cycles, 4 years, 3+1) We will replace or repair any cell that due to a manufacturing defect fails to give 80% of the rated capacity shown in o</i>

British Standard 2 Volt Cells

All our traction battery cells come in 3 formats, British Standard (often seen written as BS) being one of them. These cells are all the same width with multiple height, length & weight specifications to enable a perfect fit for a range of applications.



For sales & service throughout the UK & Ireland, please contact Battery Service Hub Ltd
tel | 01858 433008 fax | 01858 433563 email | info@batteryservicehub.com
website | www.batteryservicehub.com

Battery Service Hub Ltd, Pegasus House, Riverside End, Market Harborough, Leicestershire, LE16 7PU, United Kingdom