

4 EPzV 220

Additional information

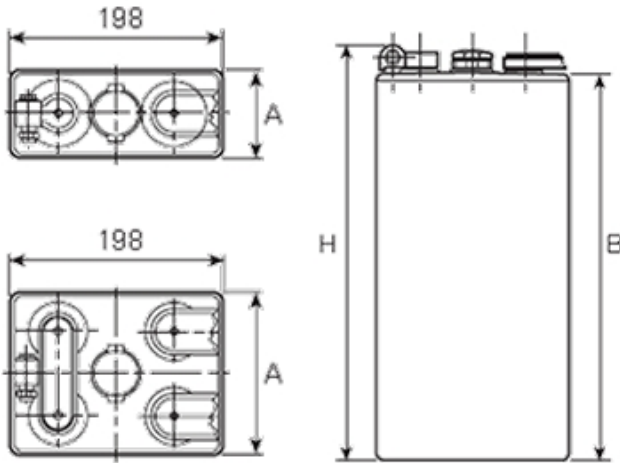

Brand	<i>Pegasus</i>
Range	<i>DIN Standard – GEL – 2 Volt Cell</i>
Volts	2
Number of plates	4
Cap [C5 Ah]	220
Weight	16.3 kg
Length	83 mm
Width	198 mm
Height	342 mm
Terminal Type	FM10
Technology	GEL
Guarantee/Warranty	<i>PzV PzVBS Valve Regulated Batteries (1200 cycles, 3 years, 1+2)</i>

DIN Standard 2 Volt Cells (GEL)

All our traction battery cells come in 3 formats, GEL Standard being one of them. These cells are all the same width with multiple height, length & weight specifications to enable a perfect fit for a range of standard & renewable/green applications.

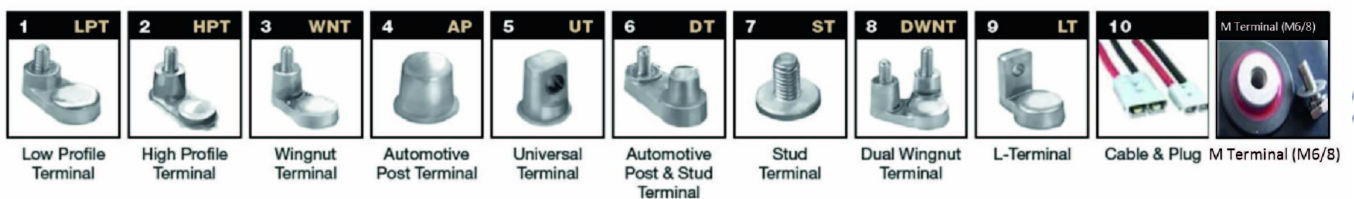

For sales & service throughout the UK & Ireland, please contact Battery Service Hub Ltd
tel | 01858 433008 fax | 01858 433563 email | info@batteryservicehub.com
website | www.batteryservicehub.com

Battery Service Hub Ltd, Pegasus House, Riverside End, Market Harborough, Leicestershire, LE16 7PU, United Kingdom