

## 8 EPzB 600

### Additional information

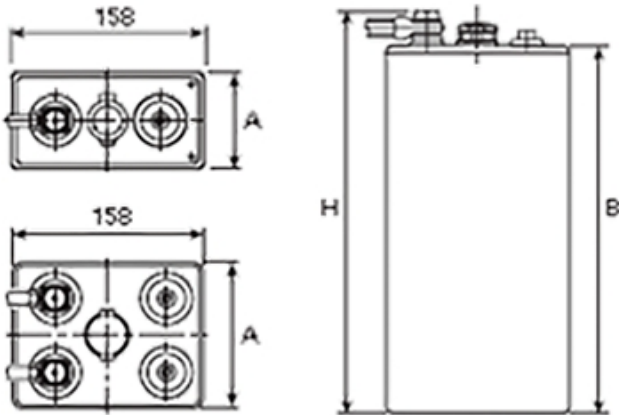

<b>Brand</b>	<i>Pegasus</i>
<b>Range</b>	<i>British Standard – Wet Vented 2 Volt Cell</i>
<b>Volts</b>	2
<b>Number of plates</b>	8
<b>Cap [C5 Ah]</b>	600
<b>Weight</b>	34.5 kg
<b>Length</b>	141 mm
<b>Width</b>	158 mm
<b>Height</b>	515 mm
<b>Terminal Type</b>	FM10
<b>Technology</b>	WET – tubular plate
<b>Guarantee/Warranty</b>	BSH Vented British Standard (BS) and DIN Batteries (1500 cycles, 4 years, 3+1)

### British Standard 2 Volt Cells

All our traction battery cells come in 3 formats, British Standard (often seen written as BS) being one of them. These cells are all the same width with multiple height, length & weight specifications to enable a perfect fit for a range of applications.



For sales & service throughout the UK & Ireland, please contact Battery Service Hub Ltd  
tel | 01858 433008 fax | 01858 433563 email | [info@batteryservicehub.com](mailto:info@batteryservicehub.com)  
website | [www.batteryservicehub.com](http://www.batteryservicehub.com)

Battery Service Hub Ltd, Pegasus House, Riverside End, Market Harborough, Leicestershire, LE16 7PU, United Kingdom